

You can now transform your home with traditional sash windows loaded with modern features

Heritage & Charisma Rose

Collection



Beautifully Crafted

PVC-u sash windows to enhance your home





“Beautifully crafted
PVC-u sash windows
to enhance your
home.”



Steeped in history and prestige – sash windows are considered by many to be the most elegant windows available on the market.

In the 18th century timber sash windows were something of a status symbol as they offered aesthetic and practical superiority compared to other windows of the era. Yet despite their beauty, timber windows brought with them issues such as rotting, peeling and rattling – problems that the modern world has little patience for.

In the 1980s PVC-u sash windows entered the market. Although they provided homeowners with a low-maintenance, easy-to-clean, simple-to-use sash window, they lacked the eye-catching, classic appeal of the 18th century original.

This is why we are pleased to introduce you to Heritage Rose and Charisma Rose. Combining high-performing modern functionality with all the charm and character of a timber original, these two stunning windows have been carefully crafted to give your home a striking combination of old and new.

Heritage Rose and Charisma Rose have been engineered to the highest quality, and have more than 25 years of experience built in. They are, quite simply, the most authentic PVC-u sash windows available on the market.

You can find out more about Heritage and Charisma Rose in this brochure and discover the difference they can make to your home. These two windows are part of the Rose Collection, a trio of sash windows that also include the Ultimate Rose. The Ultimate Rose is the premium window of the collection and more details can be found in the separate Ultimate Rose brochure.



Contents

Page 2	Heritage Rose	Page 13	Security
Page 4	Charisma Rose	Page 14	Colours, Options & Furniture
Page 6	Run-through Sash Horn	Page 15	Glass & Furniture
Page 8	Conservation & Heritage	Page 16	Commercial, Refurb's & New Builds
Page 10	Arches & Specials		
Page 12	Energy Efficiency & Sustainability		

Heritage

Rose



Heritage Rose is a prestigious and market-leading sash window that simply oozes period charm and character. For this reason, more and more homeowners across the UK are opting for Heritage Rose when replacing their windows.

Designed with all the traditional detailing found in the period era, Heritage Rose comes in a range of colours to suit your individual needs.

A number of decorative features such as authentic astragal bars and the optional decorative run-through sash horn ensure complete authenticity and make this window virtually indistinguishable from a timber original.

Whilst slim sight-lines create an eye-catching classic impression, the highly-engineered Heritage Rose also scores top-marks for its security and energy efficiency credentials. You can find out more about how it does this further on in the brochure.

But for now here are some more striking features, benefits and optional extras:

- A-rated, including energy efficient glazing
- Tilt facility for easy cleaning of windows from the inside
- Secured by Design enhanced window security
- Authentic Georgian bar designs and layouts
- Wide range of colours and woodgrain finishes
- Wide range of window furniture and glazing options
- Deep bottom rails, putty line glass lines and decorative sash horns, completing the authentic look
- Limit stops (also called travel restrictors) that limit how far sashes open, enhancing safety
- Woolpile covers, enhancing the authentic sightlines of the window
- High quality pre-tensioned window balances, guaranteed for ten-years of maintenance-free operation



Heritage

Rose



Ultra-slim sash and meeting stile



Run-through horn option



Authentic putty line glass lines



Authentic astragal bars available in various period designs (Internal Georgian bars also available)



Deep bottom rail



Range of textures and colours available

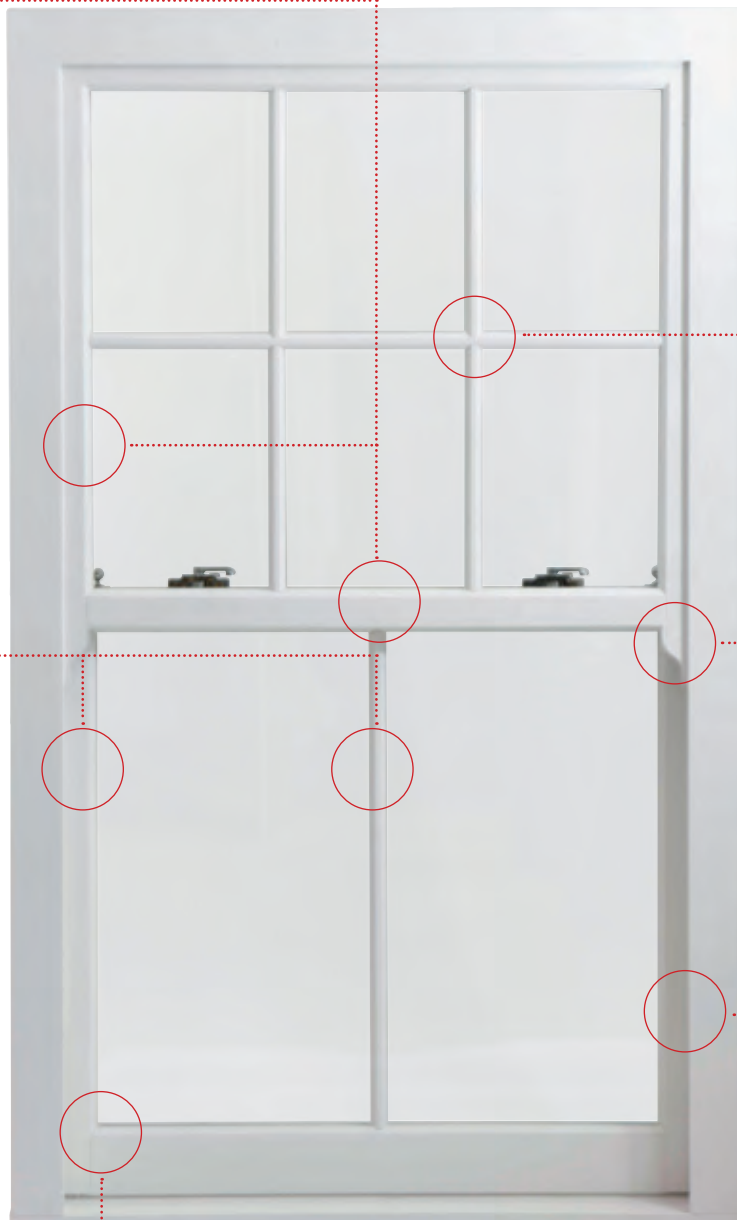

Charisma

Rose



When you choose your replacement windows you want to create an impression that reflects the character of your home. Nothing but the best is good enough. Charisma Rose offers this level of quality thanks to its cutting-edge design features which combine the eye-catching appeal of the Georgian era with the performance capabilities that only modern PVC-u products can offer.

Free from the stress of rattling, warping and rotting, they also ensure more modern properties are lent a rustic look. Made-to-measure, you can achieve real character by also adding an authentic Georgian bar. What's more Charisma Rose has been engineered so it is fully-sealed to keep your home warm, quiet and secure.

Here are some of the windows standout features:

- Exceptional draft proofing – a three-chambered frame cross section keeps cold air out and warm air in.
- Design engineering for built-in security – steel reinforced frames and tough aluminium anti-jemmy bars give you the peace of mind you need
- Intelligent fire-escape solution - meets the 'means of escape' set out in Building Regulations Part B, without compromise on style
- Tilt facility for easy cleaning of windows from the inside
- Wide range of colours and woodgrain finishes
- Maximum ventilation – designed to enable air to circulate constantly, keeping your home fresh and appealing
- Smooth gliding mechanism – the sliders are designed for easy operation and an air-tight fit
- Choice of decorative features – from Georgian bars across the panes to decorative horns, to add the finishing touches



Charisma

Rose



Ovalo featured design detail



Authentic astragal bars available in various period designs (Internal Georgian bars also available)



Modern sight lines



Clip-on horns
Run-through sash horn also available



Anti jimmy bar

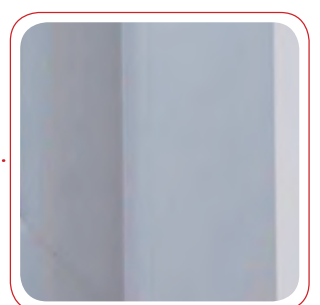

Range of textures and colours available

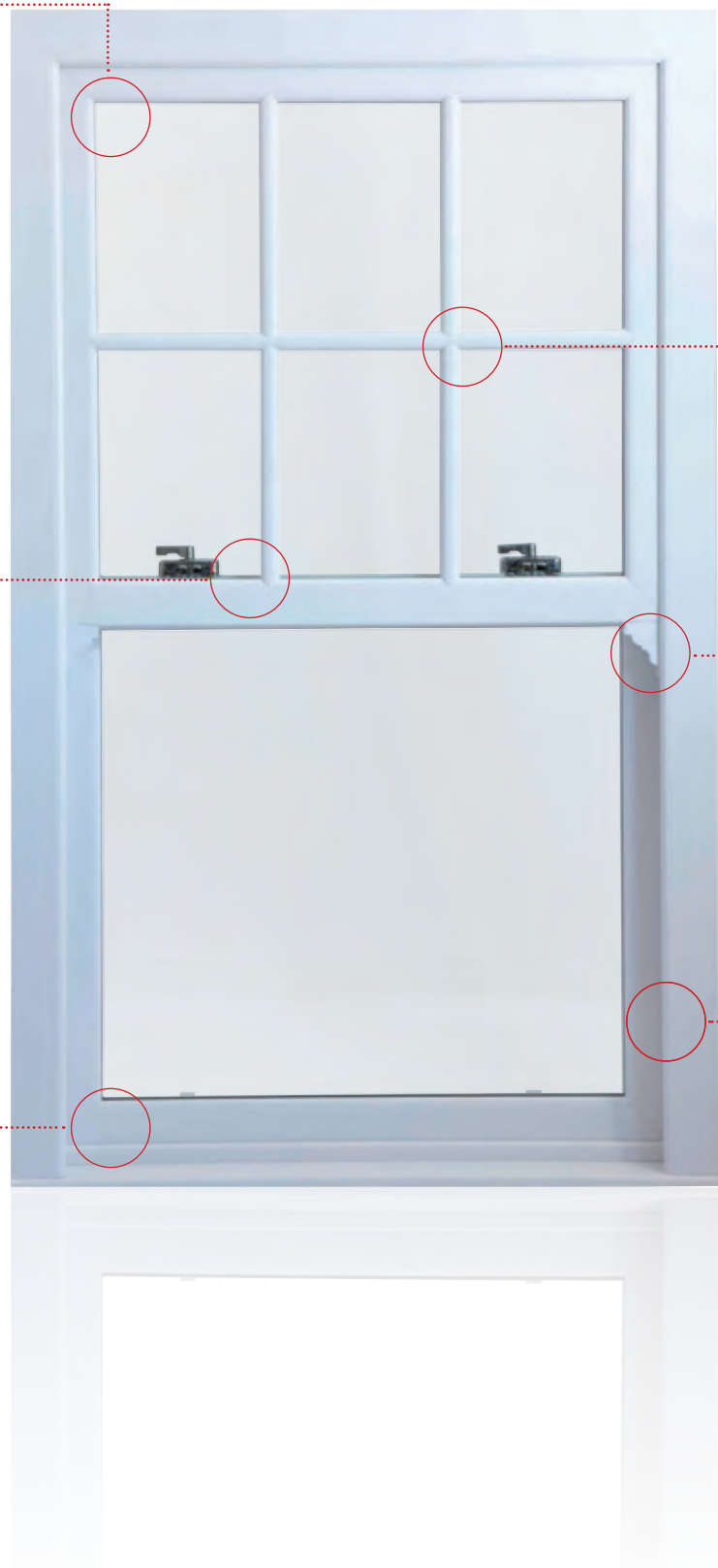

Run-through sash horns



As any conservation officer will tell you, run-through sash horns are the quintessential signature of any timber sash window. Difficulties replicating the feature in PVC-u means that many PVC-u sash windows use bolt on sash horns to replicate the look – until now.

Both Heritage Rose and Charisma Rose now come with an authentic run-through sash horn option, extending the period charm of these premium sash windows even further. Popular with conservation officers and discerning homeowners alike, run-through sash horns are the perfect finishing touch to your window.



Heritage Rose
Run-through sash horn



Charisma Rose
Run-through sash horn

Conservation options

It takes a lot of skill and manufacturing expertise to make a PVC-u sash window look like a timber original. To improve the authenticity of your window even further a number of extra features can be added in – please see right for more details. The more authentic choice is on the left hand side.

Run-through horn or clip-on horn

Choose the run-through horn for the ultimate conservation sash window or the clip-on horn for a similar look but at less cost.

Polished welds or standard welds (Heritage Rose only)

It may be a fine detail, but to replicate a painted finish we can polish out the welds.

Mechanical bottom rail or welded rail

A more cost effective method of enhancing timber feel by having just the bottom rail mechanically jointed.

Full Mechanical joints or standard welds

Replacing typical PVCu welds with full mechanical joints closely replicates original joinery detail, giving the most authentic timber look.

Please note that the full mechanical joints are only available on the Ultimate Rose window - see separate brochure for details.

Run-through Sash Horn



Clip-on Horn



Polished Welds



Standard Welds



Mechanical Bottom Rail



Welded Bottom Rail



Full Mechanical Joints



Standard Welds

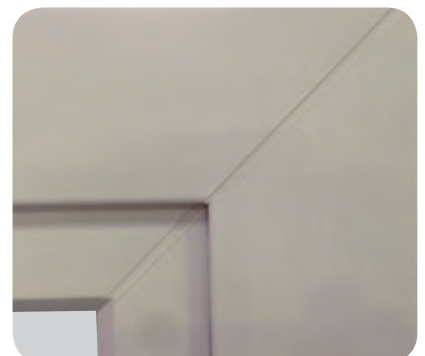

Conservation & Heritage

Heritage Rose has been specifically designed to mimic the aesthetics of a traditional timber sash window.

The product is held in high esteem and is one of the few PVC-u sash windows to be accepted in sensitive conservation areas where timber, not PVC-u is normally the frame material of choice.

Thanks to authentic features such as deep bottom rails, slim sightlines, putty lines and run-through sash horns, a growing number of conservation officers have deemed the window suitable for a heritage setting.

Here is a list of conservation areas Heritage Rose has been installed in:

- Royal Borough of Chelsea and Kensington
- Denbighshire County Council
- Flintshire
- Torfaen Council
- Bristol City Council
- Plymouth City Council
- Herefordshire County Council
- Cheltenham Borough Council
- Tamworth Borough Council
- Northamptonshire County Council
- Weybridge
- Mid Bedfordshire District Council
- Dublin Corporation
- Isle of Wight Conservation
- St. Pauls (Bristol)
- Caradon District Council
- London Borough of Brent
- Bedfordshire County Council
- Hull City Council
- Yorkshire
- Erewash District Council
- Wakefield Borough Council
- Lake District National Park
- South Lakes District Council
- Wandsworth Council
- Newmarket
- Brighton & Hove City Council
- London Borough of Camden
- London Borough of Hammersmith and Fulham



Conservation & Heritage



One of these windows is our Heritage Rose model with a run-through sash horns, the others are timber originals - can you tell which one?



Arches & Specials

Both Heritage Rose and Charisma Rose are available in a stunning choice of curved or arched heads to suit your individual taste. See right for more information.



Arched windows



Triples



Unequal splits



Slim Mullion Combinations
(Heritage Rose only)



Bays



Heritage Rose and Charisma Rose are available in a choice of Georgian, Victorian and Edwardian bar designs. See below to choose the one that's right for you.

Edwardian



Georgian



Victorian



Many other bar designs are available – please ask for more details

Energy

Efficiency & Sustainability

You'll be more than aware that energy bills are rising and concerns related to the environment are a presiding influence. The replacement windows you choose can make a huge difference to both these issues.

The window industry has an energy rating scheme which checks the energy efficiency of products such as sash windows. You may be familiar with it as it is the same system used for domestic appliances such as washing machines and boilers.

If you have an 'A' rated window this means you have the maximum thermal efficiency available, giving you significant savings on your energy bills whilst also helping you do your bit for the environment. And the authoritative Green Guide published by the BRE (Building Research Establishment) rates PVC-u as equal to or better than timber windows when it comes to sustainability, environmental impact and energy efficiency. So you can be assured that selecting PVC-u sash windows is environmentally responsible.

Furthermore, you'll be pleased to know that both the Heritage and Charisma Rose come with an 'A' rated option – meaning you will be helping the environment, reducing bills and creating a warmer and more relaxed living space. And unlike timber windows, Heritage and Charisma Rose won't rot, warp or lose performance following repeated attacks from the elements, meaning their good looks will last well into the future.



Energy Window

0725-002A

Heritage Rose & Charisma Rose

Roseview Windows

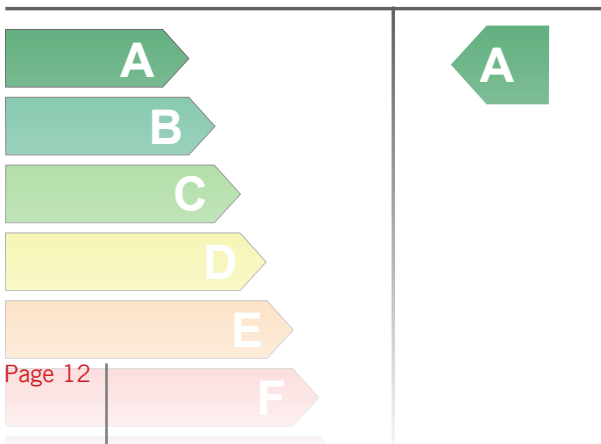

Security

Secured by Design



Official Police Security Initiative

Along with being great looking, cost-effective and energy efficient, it is crucial that your windows are as secure as they possibly can be.

To provide an official yard-stick to measure the security credentials of windows and other products in the UK, the police introduced an initiative called Secured by Design (SBD). Based on the Enhanced Window Security British Standard (BS 7950), SBD scrutinises windows via stringent tests and then recommends the ones that have the strongest security designed-in.

Only companies that have been screened by the Association of Chief Police Officers and whose products have passed this stringent testing may be registered as 'Secured by Design'.

You can rest assured that both Charisma Rose and Heritage Rose have achieved this status thanks to their world leading hardware and other security additions. The result is a set of windows that will keep your home safe from any would-be intruders.



Enhanced SBD lock

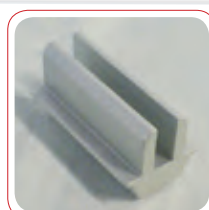

Sash Jamb

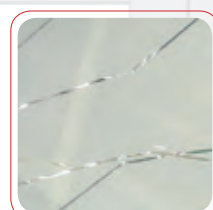

Laminated security glass

(SBD is available as an optional extra to Heritage Rose and Charisma Rose windows within certain size restrictions)

Colour Options and Furniture

No two homes are the same, which is why it is important your windows perfectly match the look of your property. Both Heritage and Charisma Rose can be styled to suit your individual taste, offering a selection of colours across the frame, gasket, spacer bar and furniture. See below for more information.

Heritage Rose

Frame Colours	 White	 White Woodgrain	 Cream Woodgrain
	 Rosewood	 Golden Oak	
Gaskets	 White	 Black	 Grey
Spacer Bar	 White	 Black	 Silver
Furniture	 White	 Chrome	 Satin
	 Gold	 Black	 Rose Etched Design

Charisma Rose

Frame Colours	 White	 White Woodgrain	 Solid Cream
	 Cream Woodgrain	 Rosewood	 Golden Oak
Gaskets		 Irish Oak	 Black
Spacer Bar	 White	 Black	 Silver
Furniture	 White	 Chrome	 Satin
	 Gold	 Black	 Rose Etched Design

Other frame colours are available as a special order

Glass is a significant part of any window, that's why Heritage Rose and Charisma Rose are available with a number of glass options to suit your individual taste. A choice of window furniture completes the picture. Please see below to choose the option that's right for you.

Glass Options



Satin



Stippolyte

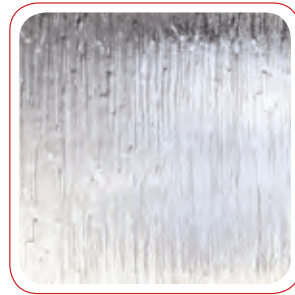

Cotswold



Contoura

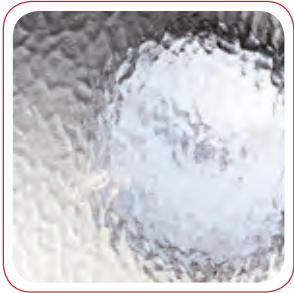

Minster



Canterbury



Acoustic



More options available on request

Furniture Options



Shark Fin - Limited Stop



Rola - Limited Stop



Pole Eye



Sash Lift



D-Handle



Two Point Locking



Tilt Knob



Cam Catch

Commercial

Refurb's & New Builds

Commercial

1985 was the year the first generation Heritage Rose was installed in a commercial property. Over two decades later and both Heritage Rose and Charisma Rose have been specified in thousands of jobs in the commercial sector.

Both products have evolved with the times. The experience gained over the past 27 years has been fed back into the manufacturing facility and is the reason both Heritage Rose and Charisma Rose are two of the best sash windows on the market today.

Refurbishment

Similarly, both Heritage and Charisma Rose have been incorporated within a number of major refurbishment projects.

An example of this is Parkwood– a prestigious school that's owned and run by The Royal Borough of Kensington and Chelsea. Parkwood School was built in the 1890s and Heritage Rose was used to replace over 200 original oak framed windows at the front and back of the building.

It wasn't long before the school owners were seeing the benefits of having Heritage Rose used in their prestigious building. Thanks to the product's thermal performance and specialist glass, Parkwood were able to turn their heating system off two months earlier than usual.

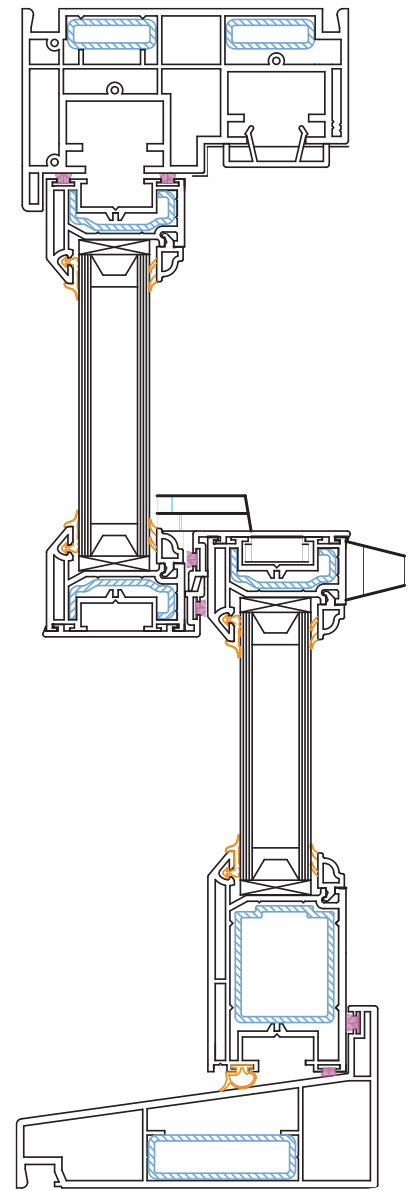

New Build

With Heritage Rose and Charisma Rose firmly established as leading products on the market today, it's no surprise the number of local planners and conservation officers specifying both windows continues to increase.

For example, Charisma Rose was recently installed in a multi-million pound project on behalf of major construction company Balfour Beatty.

The windows were fitted into luxury apartments in Beaconsfield, Hertfordshire and were chosen because of their traditional good looks and modern high performance.



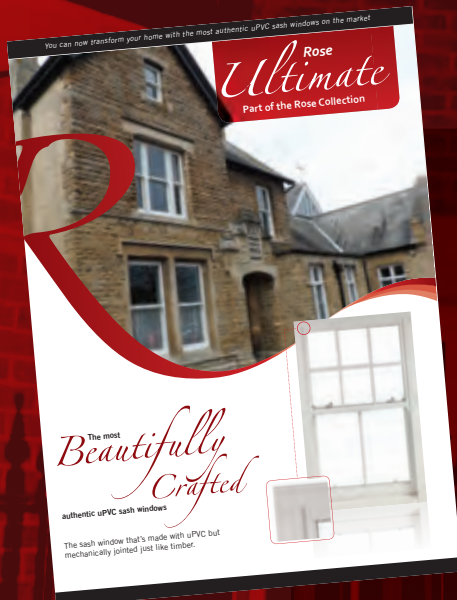

Also available,
G13 New Product
of the Year -
The Ultimate Rose
Request your copy today

Your local installer of Heritage and Charisma Rose sash windows:

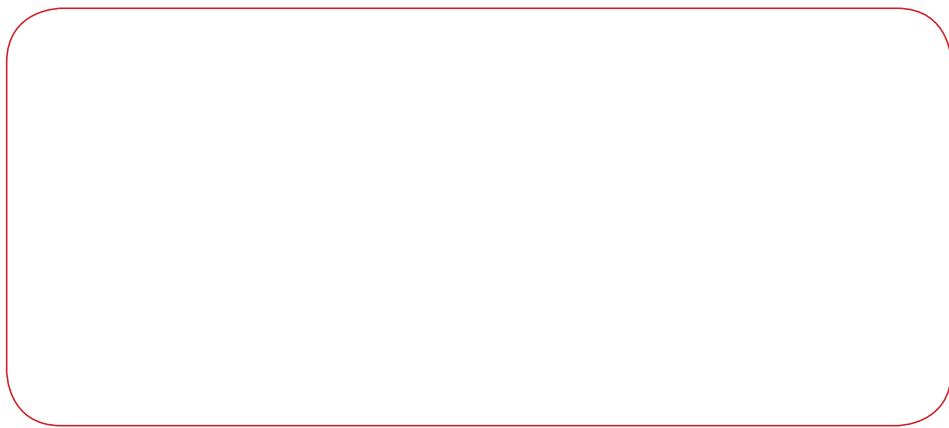

Manufactured by

Roseview
windows

